



## *T3111 TRANSMITTER*

**Programmable transmitter of temperature, relative humidity  
and other derived humidity values with 4-20 mA outputs**

### **Instruction Manual**



**TR Automatyka Sp. z o.o.**  
ul. Lechicka 14, 02-156 Warszawa  
NIP 522-27-58-993

tel. +48 (22) 886 10 16, fax +48 (22) 846 50 37  
<http://www.trautomatyka.pl/>  
[biuro@trautomatyka.pl](mailto:biuro@trautomatyka.pl)

Sąd Rejonowy dla M.St Warszawy XIII Wydział Gospodarczy KRS 0000232574  
kapitał zakładowy 50000PLN - opłacony w całości

# Instruction manual for use of T3111 transmitters

Transmitter is designed for measurement of air temperature at °C or °F and relative humidity of air without aggressive ingredients with computing one of the following values: dew point temperature, absolute humidity, specific humidity, mixing ratio and specific enthalpy. Instrument is equipped with an external humidity and temperature probe on a cable. The probe is a non-removable instrument part. Measured and computed values are displayed on dual line LCD display. The first line displays temperature. Value displayed on the second line is selectable among relative humidity and computed value. It is also possible to display both readings with cyclic overwriting in 4 seconds interval. It is possible to switch OFF the LCD at all. Transmitter is connected to circuitry by means of one or two **galvanic isolated** loops. Each loop has two-wire connection and each loop requires power from evaluation device. It is always necessary to connect current loop I1 for proper transmitter function (from loop I1 part of the transmitter is powered). If current loop I1 is opened or disconnected, then loop I2 and LCD will not work. It is possible to assign measured value to current loop output I1 or output I2 (both two-wire connection). Please read instruction manual before the first device connection.

All transmitter setting is performed by means of the PC connected via the optional SP003 communication cable (not included in delivery). Program *Tsensor* for transmitter setting is available to download free at [www.cometsystem.cz](http://www.cometsystem.cz). Program enables to assign each current loop output measure value (temperature, relative humidity, computed value) and its range. It supports make the adjustment of the device too. This procedure is described at file „*Calibration manual.pdf*“ which is installed commonly with the software. It is also possible to assign both outputs to the same value (with the same range), if two evaluation devices are necessary to connect.

## Device setting from the manufacturer

Transmitter is set from the manufacturer to the following parameters:

**value at output I1:** relative humidity, range 4 – 20 mA corresponds 0 to 100 % RH

**value at output I2:** temperature, range 4 – 20 mA corresponds -30 to +105 °C

**display:** switched ON

**value displayed at line 2:** relative humidity only

**Modification of the setting is possible to do by means of the PC using procedure described at the end of this document.**

## Installation of the transmitter

Transmitter case with electronics is designed for wall mounting. It is NOT recommended to use the probe for long time under condensation conditions. It could be the cause of water steam condensation inside the sensor's cover into water phase. This liquid phase stays inside sensor's cover and can't escape from the cover easily. It can dramatically increase response time to relative humidity change. If water condensation occurs for longer time it can cause sensor damage. Similar effect can occur under water aerosol conditions. If this effect may occur, it is necessary to use the probe at operation position with sensor cover downwards. Don't connect transmitter while power supply voltage is on. Interconnection terminals are accessible after unscrewing four screws and removing the lid. Lace the cable through a gland at the case wall. Connect the cable to terminals with respecting the signal polarity (see figure). Terminals are self-clamping and can be opened by a suitable screwdriver. For the opening, insert the screwdriver to upper terminal hole and lever by him. Do not remember to tighten glands and case lid with inserted packing after cables connecting. It is necessary for warranting of protection IP65.

It is recommended to use shielded copper cable (e.g. SYKFY) with outside diameter of the cable must be from 3.5 to 8 mm, maximal length 1200m. The cable must be located at indoor rooms

(probe is not protected for outdoor use). The cable should not be led in parallel along power cabling. Safety distance is up to 0.5 m otherwise undesirable induction of interference signals can appear.

Electrical system (wiring) may do only worker with required qualification by rules in operation.

## Dimensions

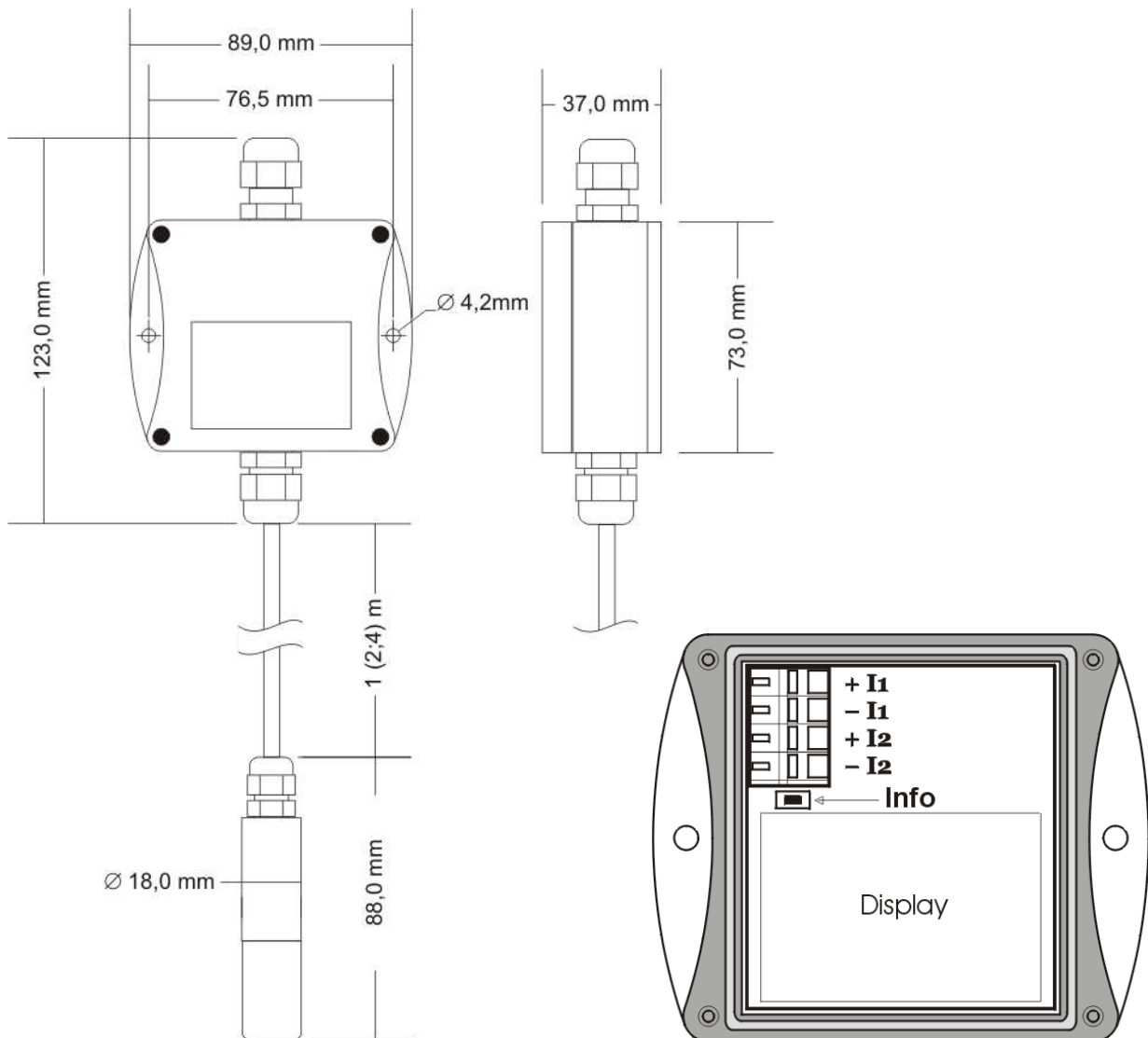

## Typical application wiring

Calculation of minimum power voltage  $U_{ss}$  for proper operation:

$$U_{ss \min} > U_{o \min} + I_{\max} * R_z,$$

where:  $U_{o \min} = 9 \text{ V}$

$I_{\max}$ ... approximately 20 mA

$R_z$ ... sensing resistor (shunt)

Both current loops (I1 and I2) are connected analogically, current loop I1 must be always connected.

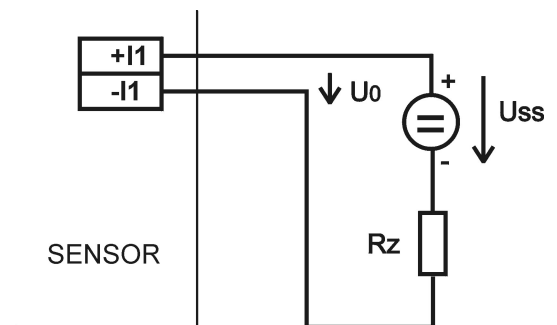

## LCD Info mode

Several settings of installed transmitter are possible to verify without a use of the computer. It is necessary to connect at least power of current loop II.

Unscrew the transmitter lid and shortly press button between display and interconnection terminals by means of a tool (e.g. screwdriver).

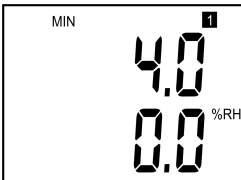

Range and type of value for output 1 (current loop II = symbol „1“ on display). Type of value, assigned to output 1, is indicated by displayed unit (here %RH = relative humidity). Upper line displays current value corresponding to measured value (lower line). Here 4 mA corresponds to 0 %RH

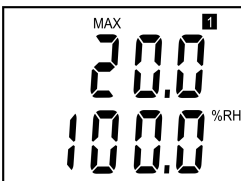

Press button again to get value for upper point (same output, same value) similarly as at previous point. Here 20 mA corresponds to 100 %RH.

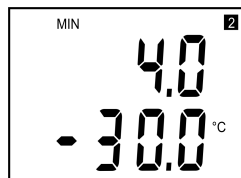

Press button again to display range and type of value for output 2 (symbol „2“). Here it is ambient temperature („°C“), when 4 mA corresponds to -30 °C.

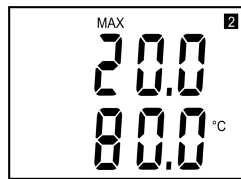

After next press of the button value for upper point appears, here 20 mA corresponds to ambient temperature 80 °C. Press button again to end info mode and display actual measured values.

**Notice:** during info mode no measurement and no output current generation proceed. The transmitter stays at info mode 15 s, and then automatically goes back to measuring cycle.

## Procedure of modification of transmitter adjustment:

- device adjustment is performed by means of the optional SP003 communication cable, connected to USB port of the PC.
- It is necessary to have installed configuration program Tsensor on the PC, It is free to download at [www.cometsystem.cz](http://www.cometsystem.cz). During installation please take care about installation of driver for USB communication cable
- Connect SP003 communication cable to the PC. Installed USB driver detect connected cable and create virtual COM port inside the PC.
- Unscrew four screws of the device lid a remove the lid. If device is already installed to measuring system, disconnect leads from terminals
- Connect SP003 communication cable to the device. Display must light up, or at least must light up all symbols for one second (if LCD was switched OFF by program before).
- Run installed Tsensor program and select corresponding communication COM port (as described above).
- When new setting is saved and finished, disconnect the cable from the device, connect leads into its terminals and place the lid back to the device.

## Readings on LCD display

**°C, °F**

Reading next to this symbol is measured temperature or error state of value.

**%RH**

Reading next to this symbol is measured relative humidity or error state of value.

**°C / °F DP**

Reading next to this symbol is calculated dew point temperature or error state of value.

**g/m<sup>3</sup>**

Reading next to this symbol is calculated absolute humidity or error state of value.

**g/kg**

Reading next to this symbol is calculated specific humidity or mixing ratio (depends on device setting) or error state of value.

If specific enthalpy is selected, there is shown only value (number) without corresponding unit!

## Technical parameters:

Accuracy data shown are for value displayed on LCD display. For value on analog output is valid too, if selected output range is set inside measuring range.

### Analog outputs:

Two galvanic isolated current loops with range from 4 to 20 mA

Current output in case of error: <3.8 mA or >24 mA

**Power: 9 to 30 V dc**, maximum ripple 0.5 %

### Measuring parameters:

**Ambient temperature** (internal RTD sensor Pt1000/3850ppm):

Measuring range: -30 to +105 °C

Display resolution: 0.1 °C

Accuracy: ± 0.4 °C from -30 to 105 °C

**Relative humidity** (RH reading is compensated at the entire temperature range):

Measuring range: 0 to 100 %RH (see Installation of the transmitter)

Display resolution: 0.1 %RH

Accuracy: ± 2.5 %RH from 5 to 95 %RH at 23 °C

Measuring temperature and humidity range is limited in accordance with the graph below!

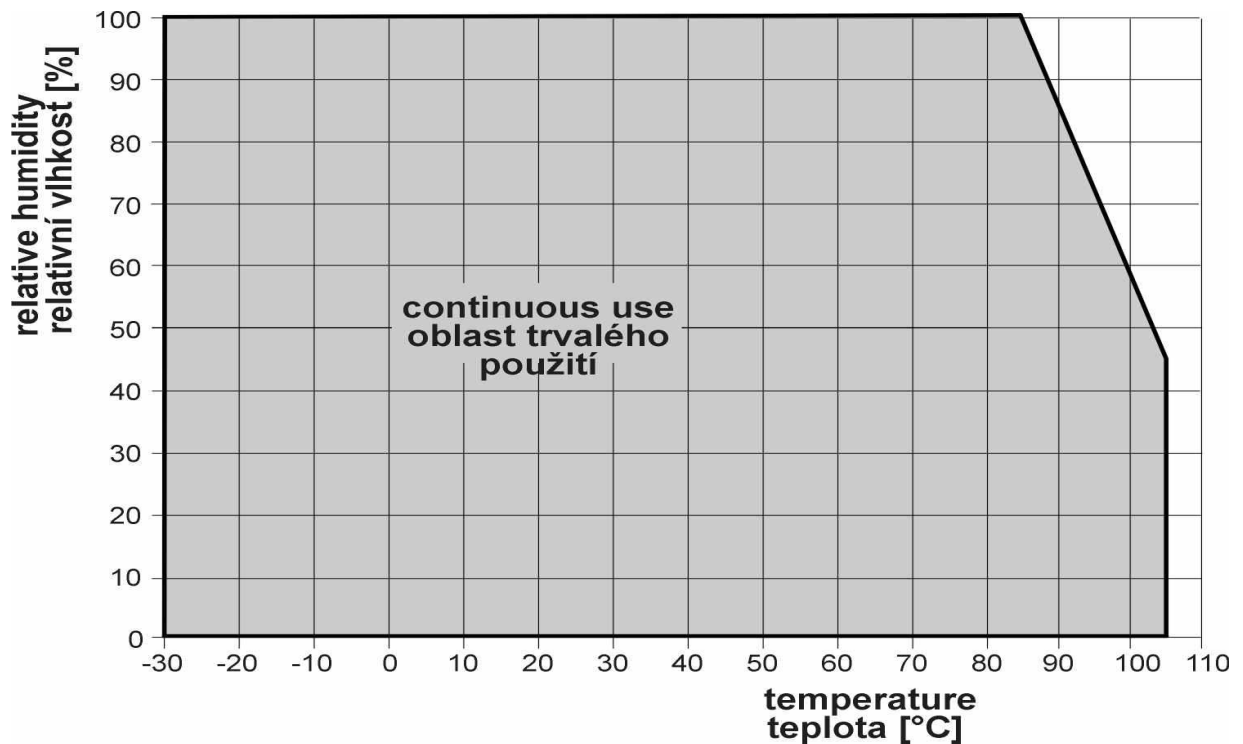

The value computed from ambient temperature and relative humidity:

Display resolution: 0,1 °C

You can choice one of the next value:.

#### Dew point temperature

Accuracy:  $\pm 1,5$  °C at ambient temperature  $T < 25$ °C and RH  $> 30\%$

Range: -60 to +80 °C

#### Absolute humidity

Accuracy:  $\pm 3$ g/m<sup>3</sup> at ambient temperature  $T < 40$ °C

Range: 0 to 400 g/m<sup>3</sup>

#### Specific humidity<sup>1</sup>

Accuracy:  $\pm 2$ g/kg at ambient temperature  $T < 35$ °C

Range: 0 to 550 g/kg

#### Mixing ratio<sup>1</sup>

Accuracy:  $\pm 2$ g/kg at ambient temperature  $T < 35$ °C

Range: 0 to 995 g/kg

#### Specific enthalpy<sup>1</sup>

Accuracy:  $\pm 3$ kJ/kg at ambient temperature  $T < 25$ °C

Range: 0 to 995 kJ/kg <sup>2</sup>

**Response time** with stainless steel mesh sensor cover (F5200B) and bronze sensor cover (F0000 - selectable option), air flow approximately 1 m/s:  
 temperature:  $t_{90} < 6$  min (temperature step 20 °C)

<sup>1</sup> This value depends on the atmospheric pressure. For computing is used constant value stored inside device memory. Default value preset by manufacturer is 1013hPa and can be changed by user's software.

<sup>2</sup> This maximum is reached under conditions about 70°C/100%RH or 80°C/70%RH

relative humidity:  $t_{90} < 30$  s (humidity step 65 %RH, constant temperature)  
Recommended interval of calibration: 1 year  
Measuring interval and LCD display refresh: 0.5 s  
Communication with computer: via USB port by means of USB communication cable SP003  
Protection: electronics IP65, sensors are located in cover with IP40 protection  
Air filter: filtering ability 0.025 mm  
Operating conditions:  
Operating temperature range of case with electronics: -30 to +80 °C, over +70°C switch LCD display off  
Operating temperature range measuring tip with sensors: -30 to +105 °C  
Operating humidity range: 0 to 100 %RH  
Outer characteristics in accordance with EN 33-2000-3:  
normal environment with the specifications: AE1, AN1, BE1  
Working position: negligible (see Installation of the transmitter)  
Electromagnetic compatibility: complies EN 61326-1  
Not allowed manipulations:  
It is not allowed to operate the device under other than specified conditions in technical parameters. Devices are not designed for locations with chemically aggressive environment. Temperature and humidity sensors must not be exposed to direct contact to water or other liquids. It is not allowed to remove the sensor cover to avoid any mechanical damage of the sensors.  
Storing conditions: temperature -30 to +80 °C, humidity 0 to 100 %RH without condensation  
Dimensions: the case with electronics 89 x 73 x 37 mm, external probe: Ø18 mm, length approximately 90 mm, standard cable length 1 m  
Weight: approximately 115 g  
Material of the case: ABS

## Error States of the device

Device continuously checks its state during operation. In case error is found LCD displays corresponding error code:

### Error 0

First line displays „Err0“.

Check sum error of stored setting inside device's memory. Output value is  $< 3.8$  mA. This error appears if incorrect writing procedure to device's memory occurred or if damage of calibration data appeared. At this state device does not measure and calculate values. It is the serious error, contact distributor of the instrument to fix.

### Error 1

Measured (calculated) value is over upper limit of allowed full scale range. There is a reading „Err1“ on LCD display. Output value is about 24.5 mA. This state appears in case of:

- Measured temperature is higher than approximately 600°C (i.e. high non-measurable resistance of temperature sensor, probably opened circuit).
- Relative humidity is higher than 100%, i.e. damaged humidity sensor, or humidity calculation of humidity is not possible (due to error during temperature measurement)
- Computed value – calculation of the value is not possible (error during measurement of temperature or relative humidity or value is over range)

## **Error 2**

There is a reading „Err2“ on LCD display. Output value is about 3.8 mA. Measured (calculated) value is below lower limit of allowed full scale range. This state appears in case of:

- Measured temperature is lower than approximately -210°C (i.e. low resistance of temperature sensor, probably short circuit).
- Relative humidity is lower than 0%, i.e. damaged sensor for measurement of relative humidity, or calculation of humidity is not possible (due to error during temperature measurement)
- Computed value – calculation of computed value is not possible (error during measurement of temperature or relative humidity)

## **Error 3**

There is a reading „Err3“ on LCD display upper line.

Error of internal A/D converter appeared (converter does not respond, probably damage of A/D converter). No measurement and calculations of values are proceeded. Output value is about 3.8 mA. It is a serious error, contact distributor of the instrument.

## **End of operation**

Device itself (after its life) is necessary to liquidate ecologically!

## **Technical support and service**

Technical support and service is provided by distributor. For contact see warranty certificate.



**TR Automatyka Sp. z o.o.**  
ul. Lechicka 14, 02-156 Warszawa  
NIP 522-27-58-993

tel. +48 (22) 886 10 16, fax +48 (22) 846 50 37  
<http://www.trautomatyka.pl/>  
[biuro@trautomatyka.pl](mailto:biuro@trautomatyka.pl)

Sąd Rejonowy dla M.St Warszawy XIII Wydział Gospodarczy KRS 0000232574  
kapitał zakładowy 50000PLN - opłacony w całości